

SBIG

Model AO-8

Adaptive Optics

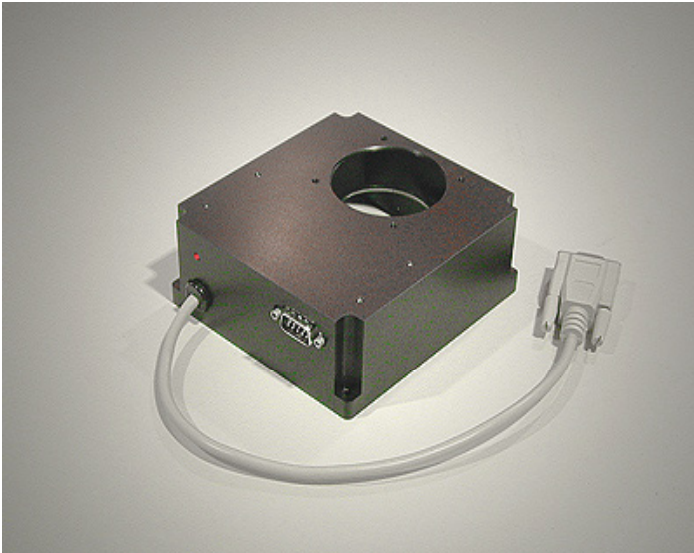

Installation and Operation

Manual

Copyright 2007
Santa Barbara Instrument Group, Inc.

Introduction

Congratulations on your purchase of the AO-8, a second-generation Adaptive Optics device for your dual sensor ST series camera. Please take the time to read these instructions and carefully review your software's operating instructions for an SBIG AO. Each software program that supports the AO will have its own unique menu and set of commands. We therefore limit the instructions in this manual to installation of the device and an overview of its operation.

IMPORTANT: Read Appendix A for Cautions before connecting the AO-8 to your camera. Remove the bottom cover and take any foam or packing material out of the unit before operation.

AO-8 Design

SBIG's previous adaptive optics accessory, the AO-7, consumed quite a bit of back focus due to the use of a mirror at 45 degrees. It's alignment was quite critical since it could shift the optical axis considerably if misaligned, and it was also somewhat delicate due to the use of a membrane under tension in two axes to support the mirror. In addition, it had an issue with image rotation at large deflections, which becomes serious for large CCDs, but was not a problem for the smaller CCDs of the ST series. For these reasons SBIG designed a new Adaptive Optic device for high speed beam steering called the AO-L (Adaptive Optic – Large Format), which could cover the larger CCDs. The same approach has been extended to the ST camera line with the AO-8, a less expensive unit for smaller CCDs, but operating in much the same way. It is shown in an exploded view above.

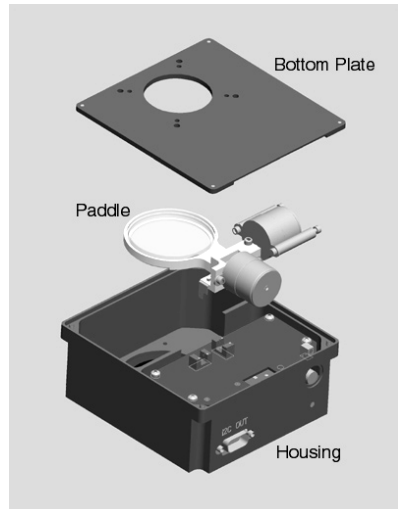

Incoming light passes through a 6 mm thick plane parallel plate that can be tilted by the action of two geared stepper motors. The total amount of tilt in each direction is ± 9.6 degrees. The light beam is deviated by 36 microns per degree of tilt, so the maximum deviation is ± 346 microns, or ± 38 pixels with an ST-7/8. We have done careful ray tracing to convince ourselves that no focal shift or significant aberration occurs as the plate is tilted over these small angles, nor is there any distortion, rotation, or change in magnification. Our testing has verified these results. The window is AR coated with the same high quality coating on our ST chamber window, and has less than 1% reflection per surface from 400 to 900 nm wavelength.

The AO-8 is somewhat slower than an AO-7, since the motor and gearbox can only tip the motor at 18.75 degrees per second, or 75 pixels per second. In this design moves are slew-rate limited. What this means to the user is that the user should use a focal length that does not produce too large of a star image. For example, if the seeing is bad and the star is 9 pixels across, it is probably jumping around by 4.5 pixels or so with each look, which would take 60 milliseconds to move. If under such conditions you reduced your focal length to where the star was only three pixels across, only 20 milliseconds are spent making the move, and you can achieve a higher update rate with the AO-8. The total overhead in the software for an AO-8 move is 45 milliseconds. If, for example, you are taking 50 millisecond exposures with an optimized focal length (~ 3 pixel Full Width Half Maximum stars), the total cycle time is $45 + 50 + 20$ ms, or 115 ms (8 updates per second). The AO-7 advantage was that a move of any length is 20 milliseconds, but the exposure and overhead times were similar. Based on our experience and knowledge, the corrections made by the AO-8 help with reducing ground layer atmospheric turbulence, and are quite effective in reducing guide errors and wind buffeting. The smallest increment of move for the AO-8 is 0.075 degrees per axis, or 2.7 microns, about a third of a pixel. A spring is included to take up the backlash in the motor gearboxes.

AO-8 Installation

The AO-8 is designed to be bolted directly to the front of an ST series camera with or without a filter wheel. In the case of the

CFW8A filter wheel, an adapter is required to provide the correct bolt pattern.

To attach the AO-8 to an ST camera without a filter wheel:

1. Remove the “D” block from the camera (4 Phillips head screws).
2. Remove the bottom plate of the AO-8 by removing the 4 hex head screws at the corners of the AO-8 housing. Remove any pieces of neoprene or foam that were inserted between the window paddle and the bottom plate during shipment. Save these in case the unit ever needs to be returned to SBIG.
3. Using the four **4-40 x 1/4 screws and washers** provided, attach the bottom plate of the AO-8 to the camera. **Appendix C, Fig 1.** Note that the smooth, featureless side of the bottom plate faces the camera and the side with the cut out faces away from the camera. Once the AO-8 bottom plate is attached, re-assemble the AO-8 housing to the AO-8 bottom plate.
5. Plug the cable from the AO-8 into the I2C-AUX port on the camera. If the CFW-9 or CFW-10 is already plugged into the I2C-AUX port on the camera, remove its connector and plug the AO-8 into the camera instead. The filter wheel will then connect to the I2C-AUX OUT port on the AO.

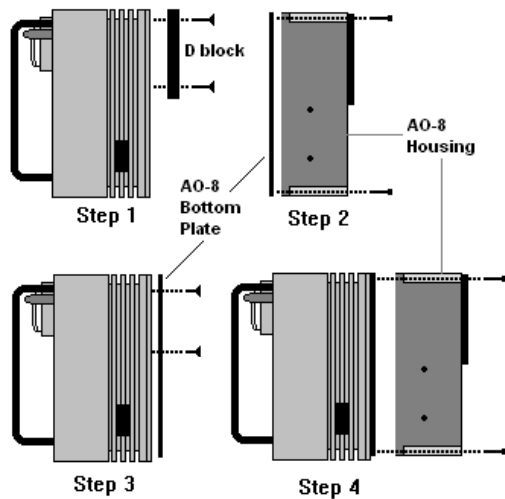

To attach the AO-8 to an ST camera with CFW9 filter wheel:

Basically you follow the steps for attaching the AO-8 to the camera, except that you attach the AO-8 bottom plate to the front cover of the filter wheel. The CFW9 has the same bolt-hole pattern as the ST camera body.

However, you will see that the filter wheel motor prevents the AO-8 from being oriented the same way as it is on a camera without a filter wheel. In this case, rotate the AO-8 bottom plate 180 degrees so that it clears the motor cover. This way, no adapter is required, however you must use the D-block that you removed from your camera as a spacer to allow the AO-8 to clear the button head screws around the edge of the CFW9 (See Appendix B for details).

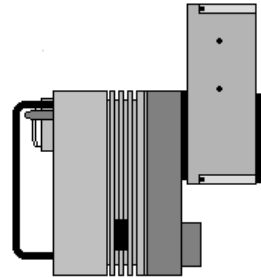

Camera + CFW9 + AO-8

Attach the AO-8 bottom plate to the filter wheel in this orientation with the D-block in between as a spacer, making sure that the smooth, featureless side of the AO-8 bottom plate faces the filter wheel and the side with the cut out faces away from the filter wheel. Finally, attach the AO-8 housing to the AO-8 bottom plate making sure that the aperture in the housing is aligned with the aperture in the bottom plate and you can see through the AO-8 and the filter wheel to the camera window. Note: If preferred, you can use the same adapter and attach the AO-8 the same way as with the CFW8A.

To attach the AO-8 to an ST camera with a CFW10 filter wheel:

Follow the steps for attaching the AO-8 to the camera, except attach the AO-8 bottom plate to the front cover of the filter wheel.

(See Appendix C, Fig 1).

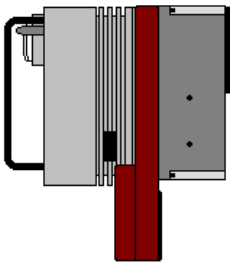

Camera + CFW10 + AO-8

The CFW10 has the same bolt hole pattern as the ST camera body, so no adapter is required. Also, the CFW10 cover is large enough that the AO-8 can be attached to it in the same orientation as it is when the AO-8 is attached to the camera body without a filter wheel.

To attach the AO-8 to an ST camera with CFW8A filter wheel:

Unlike the CFW9 and CFW10, the CFW8A filter wheel does not have the 4-hole bolt pattern on its cover to allow a direct connection of the AO-8.

Therefore, an adapter is required. This adapter picks up the bolt pattern around the perimeter of the CFW8A on one side and provides the same 4-hole bolt pattern as the ST camera on the other side. It also acts as a spacer allowing the AO-8 to clear the motor on the filter wheel so that the AO-8 does not have to be rotated 180 degrees as it does when attached to a CFW9 without an adapter, although it can be rotated if desired.

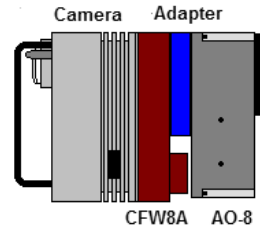

First attach the adapter to the CFW8A following the instructions that are supplied with the part. Then, attach the AO-8 to this adapter the same way as described in the previous sections. See also **Appendix C, Fig 1**.

Electrical Connections

Plug the AO-8 connector into the I2C port of the camera. The AO-8 gets its power and communicates through this one port. If a filter wheel is already using this port, unplug the filter wheel and plug in the AO-8, then you can plug the filter wheel connector into the I2C OUT jack on the AO-8 (See diagrams on next page).

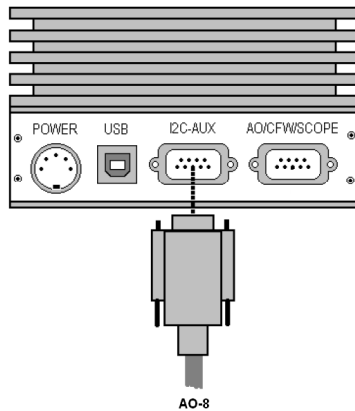

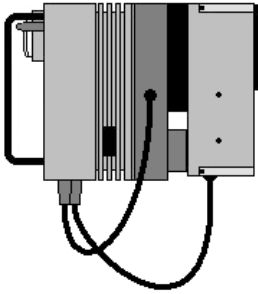

AO-8 with CFW8A

Connect the AO-8 to the I2C-AUX port on the camera.

Connect the CFW8A to the AO/CFW/SCOPE port on the camera.

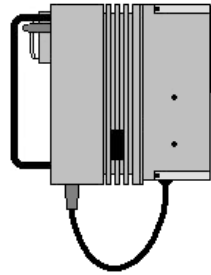

AO-8 without filter wheel

Connect the AO-8 to the I2C-AUX port on the camera

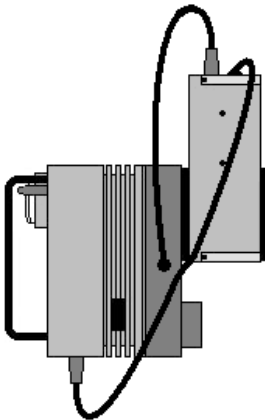

AO-8 with CFW9

Connect the AO-8 to the I2C-AUX port on the camera.

Connect the CFW9 to the I2C-OUT port on the AO-8.

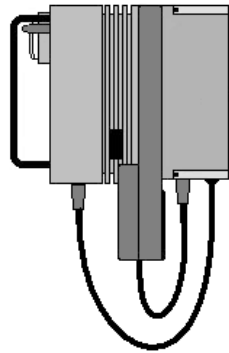

AO-8 with CFW10

Connect the AO-8 to the I2C-AUX port on the camera.

Connect the CFW9 to the I2C-OUT port on the AO-8.

Operation of the AO-8:

Most programs (CCDOPS, CCDSOFT, and Maxim DL) can perform guiding with an SBIG AO device. Check the program manuals to see how this is done. Options to just guide with the AO-8, or to guide with a combination of the AO-8 and mount moves are available. In the past AO devices have required calibration, but this is not necessary with the AO-8, once all programs implement a default calibration. At the time of this writing, only CCDOPS has a built-in default calibration so you should check with the vendor of the software you are using to see if this feature has been implemented. If the camera and AO-8 are attached to each other so that the cables all exit the units in the same direction, then the default calibration should work. If the AO-8 is attached with the cables facing the opposite direction from the camera cables (e.g., using a CFW-9 without an adapter), then use the “180 degrees” default calibration numbers. Of course, one can always do a fresh calibration with an AO-8, but it should not be required.

If the user has a good mount with accurate PEC correction then it is quite possible that the AO-8 can do all of the guiding, and no connection need be made to the mount. The BIG advantage of this is that if you need to rotate the camera-AO-8 assembly to find a guide star, you do not need to recalibrate! This is very helpful when imaging through color or narrowband filters.

Hints/Troubleshooting:

Cleaning: If the window ever needs cleaning do not remove the paddle assembly from the AO. If one removes the AO-8 housing from the camera then both sides of the glass can be reached with cotton swabs. Use cotton swabs and isopropyl (rubbing) alcohol to clean the window. Never re-use a cotton swab. Keep using fresh ones, and eventually all oil on the window will be removed. The AR coating on the window makes any residual oil very apparent.

Exercise mode: the AO-8 should re-center every time it is powered up. You can also exercise the AO-8 over its full range of operation using the AO exercise command in CCDOPS with 1 second per axis. We have never had an assembly get lost and jam at the extremes of its range, but you should contact SBIG if this should happen.

Vibration: the AO-L does vibrate substantially in exercise mode, with an easily felt buzz. This is not a problem for the much shorter moves typical of actual operation.

Dimensional Data: Back Focus: The AO-8 is 1.9 inches (48.3 mm) thick. The T-thread adapter plate adds 0.2 inches (5 mm) to this. The thick glass plate inside the AO-8 optically reduces the apparent thickness by 2 mm, so the AO-8 plus adapter plate optical thickness is a total of 2.02 inches (51.3 mm). The CFW8A adapter plate adds 0.66 inches (16.8 mm) back focus. Weight (w/o adapter): 21 ounces (0.6kg).



AO-8 attached to ST camera with 2" nosepiece (not supplied) screwed into the T-thread adapter plate.

Appendix A - Cautions

The AO-8 is packed for shipping with foam inside to protect the delicate motors from damage that might be caused by rough handling. This material prevents the paddle from moving. The AO will try to center the paddle when first powered up so it is important that you remove the foam before connecting the AO-8 to the camera or the motors could be damaged. The first piece can be removed from aperture of the AO-8 housing by simply pulling the tissue used to line the foam insert. The second piece is inside housing and can be taken out when you remove the bottom plate in preparation for installation on the camera.

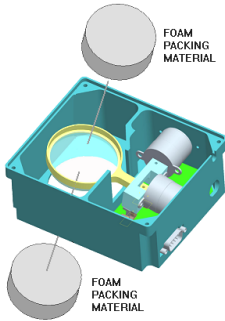

When you remove the bottom plate in preparation for installation, you will see two sets of mounting holes. The smaller inner set of four holes matches the bolt pattern on ST cameras and filter wheels. These are the mounting holes you will use. The larger, outer set of four holes matches the bolt pattern on an STL accessory plate. The larger holes are covered with black tape to prevent light from entering the AO-8 when they are unused. This tape should not be removed unless you are attaching the AO-8 to an STL camera.

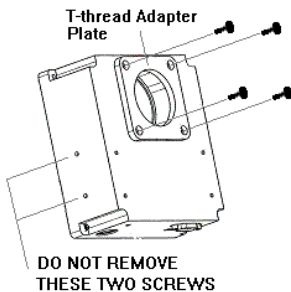
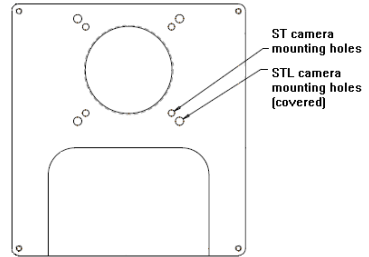

The T-thread adapter plate may be left off for shipping. If so, you can easily install it with the hex head screws and hex wrench provided. The smaller hex wrench is for removing the bottom plate from the housing. The smaller wrench also fits the two hex head screws on the side of the housing that hold the motors. Do not loosen or remove these two screws.

Be sure you have the latest SBIG drivers: Download and run the Driver Checker utility found in Software Download section IV at www.sbig.com, or go directly to our FTP site at <ftp://ftp.sbig.com/pub/SetupDriverChecker.exe>

Appendix B - Using the D-Block as a Spacer for Mounting to a CFW9

To attach the AO-8 to a CFW9 with the AO-8 rotated 180 degrees, without an adapter, you must use the D-block that you have already removed from your camera as a spacer so that the AO-8 clears the button head screws on the CFW9. Please follow these steps:

1. Loosen the three set screws on the D-block and remove the T-thread ring from the D-block. Leave the set-screws in the D-block to prevent light from entering. You can screw them in all the way to keep them secure. (Fig. 1)

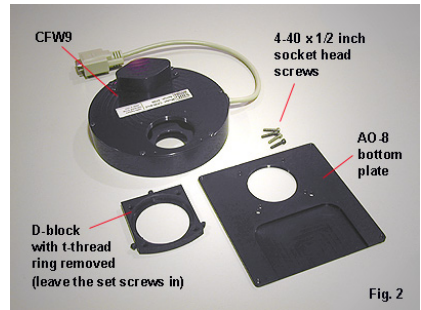
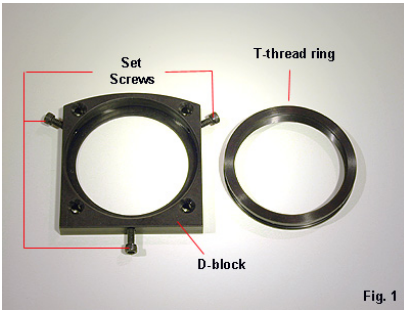

2. Use four 4-40 x 1/2 inch socket head screws to attach the AO-8 bottom plate to the CFW9 with the D-block in between as a spacer. (Fig. 2)

3. When assembled the D-block will allow the AO-8 bottom plate to be attached at 180 degrees clearing the button head screws on the CFW9. (Fig. 3)

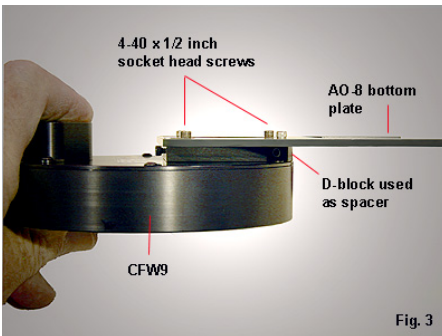

Note: It is important that you do not use screws longer than 1/2 inch as the threaded holes in the CFW9 cover plate are blind (i.e., they do not go all the way through) and 1/2 inch screws will just fit this configuration.

Appendix C - Installing the AO-8: Correct Screws and Washers

The AO-8 bottom plate mounts to the camera / filter wheel by passing screws through the bottom plate into threaded holes in the camera / filter wheel. The threaded holes are blind, that is they do not go all the way through. In order to get a rigid attachment of the AO-8 bottom plate, the screws used must be long enough to grasp the threads of the hole but not so long that they hit bottom. Forcing a screw that is too long into a blind hole will damage the threads.

There are two lengths of screws provided with the AO-8 so that it may be attached in any one of several different configurations. Appendix B describes attaching the AO-8 to a CFW9 using a D-block as a spacer. In this case, the screws are 4-40 x 1/2 inch socket head screws. No washers are used in this configuration. (Figure 2 below).

If you are making any other kind of installation (Direct to camera, or with the CFW8A adapter, or to a CFW10) then you will use shorter, 4-40 x 1/4 socket head screws AND washers to achieve the correct length (Figure 1 below)

Figure 1

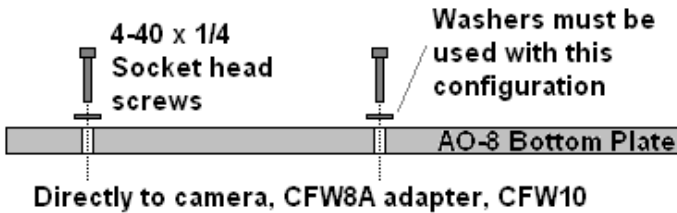

Figure 2

